

Ill. No.	Part No.	Description	Qty. Rqd.
----------	----------	-------------	-----------

FRONT EXTERNAL BODY FITTINGS

REMARKS LEGEND -

Vehicle i.d. (v) numbers:

JA = 1988 model year; LA = 1990 model year;
 MA = 1991 model year; NA = 1992 model year;
 PA = 1993 model year; RA = 1994 model year;
 SA = 1995 model year.

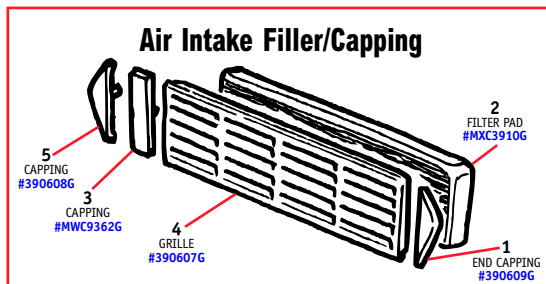

- | | | | |
|---|----------|---------------------------------------|---|
| 1 | 390609G | END CAPPING, scuttle air intake | 1 |
| 2 | MXC3910G | FILTER PAD, scuttle air intake | 1 |
| 3 | MWC9362G | CAPPING, center grille, air intake | 2 |
| | | <i>From (v) JA to NA models</i> | |
| 4 | 390607G | GRILLE, air intake | 2 |
| | | <i>From (v) JA to NA models</i> | |
| 5 | 390608G | CAPPING, center grille RH, air intake | 2 |
| | | <i>From (v) JA to NA models</i> | |

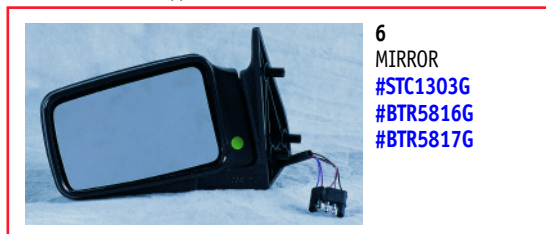

- | | | | |
|---|----------|---|---|
| 6 | STC1303G | MIRROR, LH door, flat glass | 1 |
| | | <i>Up to (v) NA models</i> | |
| | BTR5816G | MIRROR, LH door, flat glass, non-memory | 1 |
| | | <i>From (v) PA models on</i> | |
| | BTR5817G | MIRROR, LH door, flat glass, memory | 1 |
| | | <i>From (v) PA models on</i> | |

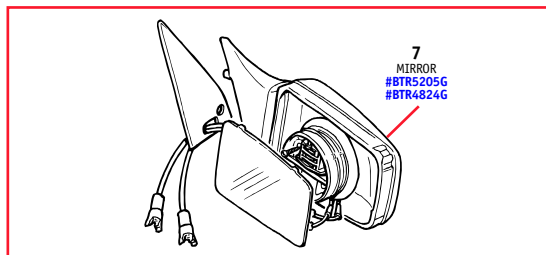

- | | | | |
|---|----------|---|---|
| 7 | BTR5205G | MIRROR, RH door, flat glass | 1 |
| | | <i>Up to (v) NA models</i> | |
| | BTR4824G | MIRROR, RH door, convex glass, non-memory | 1 |
| | | <i>From (v) PA models on</i> | |

Ill. No.	Part No.	Description	Qty. Rqd.
----------	----------	-------------	-----------

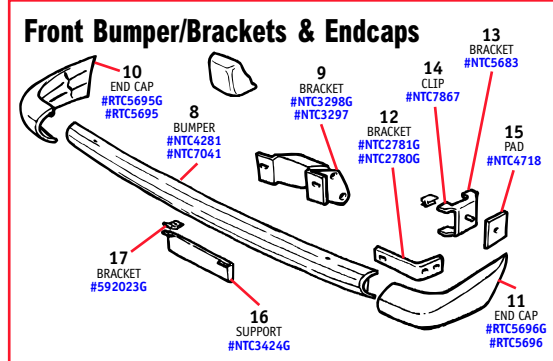

- | | | | |
|----|----------|--|---|
| 8 | NTC4281 | BUMPER, front, black | 1 |
| | NTC7041 | BUMPER, front, chrome | 1 |
| 9 | NTC3298G | BRACKET, front bumper mounting, LH | 1 |
| | NTC3297 | BRACKET, front bumper mounting, RH | 1 |
| 10 | RTC5695G | END CAP, front bumper, RH, genuine | 1 |
| | RTC5695 | END CAP, front bumper, RH | 1 |
| 11 | RTC5696G | END CAP, front bumper, LH, genuine | 1 |
| | RTC5696 | END CAP, front bumper, LH | 1 |
| 12 | NTC2781G | BRACKET, mounting end cap and bumper, LH | 1 |
| | NTC2780G | BRACKET, mounting end cap and bumper, RH | 1 |
| 13 | NTC5683 | BRACKET, end cap to body | 2 |
| 14 | NTC7867 | CLIP, bumper end bracket | 8 |
| 15 | NTC4718 | PAD, end cap bracket to body | 2 |
| 16 | NTC3424G | SUPPORT, license plate | 1 |
| 17 | 592023G | BRACKET, mounting license plate support | 2 |

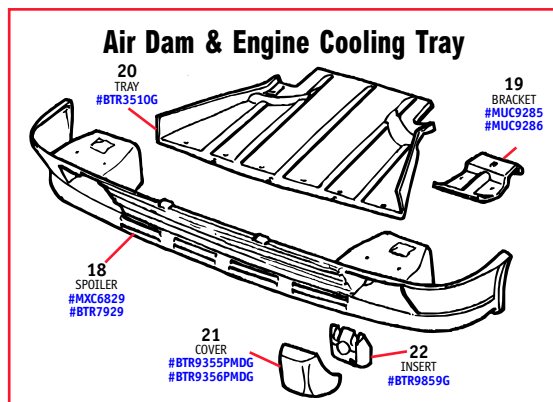

- | | | | |
|----|-------------|---------------------------------------|------|
| 18 | MXC6829 | SPOILER, front | 1 |
| | | <i>From (v) LA399973 to RA647649</i> | |
| | BTR7929 | SPOILER, front | 1 |
| | | <i>From (v) SA647650 on</i> | |
| 19 | MUC9285G | BRACKET, spoiler and driving lamp, LH | *NLA |
| | MUC9285 | BRACKET, spoiler and driving lamp, LH | 1 |
| | MUC9286 | BRACKET, spoiler and driving lamp, RH | 1 |
| 20 | BTR3510G | TRAY, engine cooling | 1 |
| | | <i>From (v) JA615503 to SA648673</i> | |
| 21 | BTR9355PMDG | COVER, crush can, LH | 1 |
| | | <i>From (v) PA models on</i> | |
| | BTR9356PMDG | COVER, crush can, RH | 1 |
| | | <i>From (v) PA models on</i> | |
| 22 | BTR9859G | INSERT, foam, crush can, LH | 1 |
| | | <i>From (v) PA models on</i> | |

Ill. No.	Part No.	Description	Qty. Rqd.
----------	----------	-------------	-----------

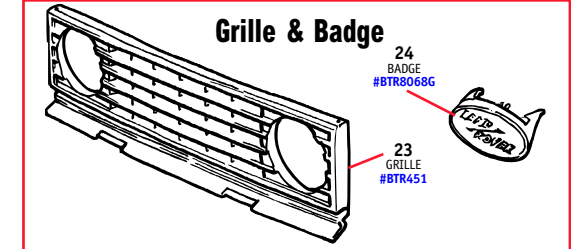

- | | | | |
|----|----------|-----------------------------|------|
| 23 | BTR451 | GRILLE, radiator | 1 |
| | | <i>From (v) MA464554 on</i> | |
| | BTR451G | GRILLE, radiator, genuine | *NLA |
| | | <i>From (v) MA464554 on</i> | |
| 24 | BTR8068G | BADGE, 'LAND ROVER', grille | 1 |

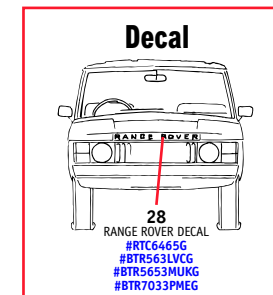

- | | | | |
|----|-------------|---|---|
| 25 | MWC6029G | SEAL, steel sunroof, front | 1 |
| | | <i>Up to (v) LA464553</i> | |
| 26 | MXC8406G | SEAL, steel sunroof, rear | 1 |
| | | <i>Up to (v) LA464553</i> | |
| 27 | EEQ100400G | SEAL, glass sunroof | 1 |
| | | <i>From (v) MA464554 on</i> | |
| 28 | RTC6465G | DECAL, 'RANGE ROVER', front, silver | 1 |
| | | <i>From (v) LA399973 to NA models</i> | |
| | BTR5653LVCG | DECAL, 'RANGE ROVER', front, dark grey | 1 |
| | | <i>From (v) PA models to PA631126</i> | |
| | BTR5653MUKG | DECAL, 'RANGE ROVER', front, mid silver | 1 |
| | | <i>From (v) PA models to PA631126</i> | |
| | BTR7033PMEG | DECAL, 'RANGE ROVER', front, black | 1 |
| | | <i>From (v) PA631127 on</i> | |

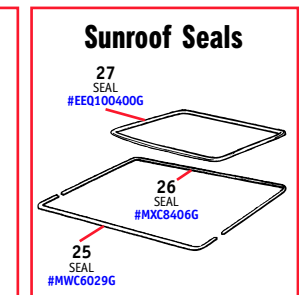

- | | | | |
|----|----------|--|-----|
| 29 | RTC9562G | MUDFLAP KIT, front | 1 |
| | | <i>Pair of mudflaps with all fixings</i> | |
| 30 | ALR2367G | LINER, front wheel arch, RH | 1 |
| 31 | STC7613G | ADHESIVE, tube, wheel arch liner | A/R |

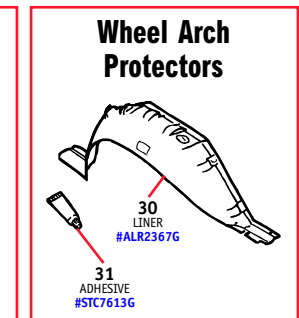

*NLA = No Longer Available



TO ORDER, CALL 1-800-533-2210